



AK5261

EL446S

CABLE REQUIREMENTS:

Colour: BLACK
Type: 3 Core 1.00mm² H05VV-F (European Approved)
Conductor Colour Codes:
 Earth (Green & Yellow) 
 Neutral (Blue) 
 Live (Brown) 

Complete Powerlead Rated: 10A/250V

PLUG / END A REQUIREMENTS:

Type: SG23AR
Colour: BLACK
Rating: 16A
Reference: Right Angled Schuko (European Approved)

CONNECTOR / END B REQUIREMENTS:

Type: SG597R
Colour: BLACK
Rating: 10A
Reference: R/A C13 IEC Lock+ Connector (European Approved)



Right Angle 90 degrees

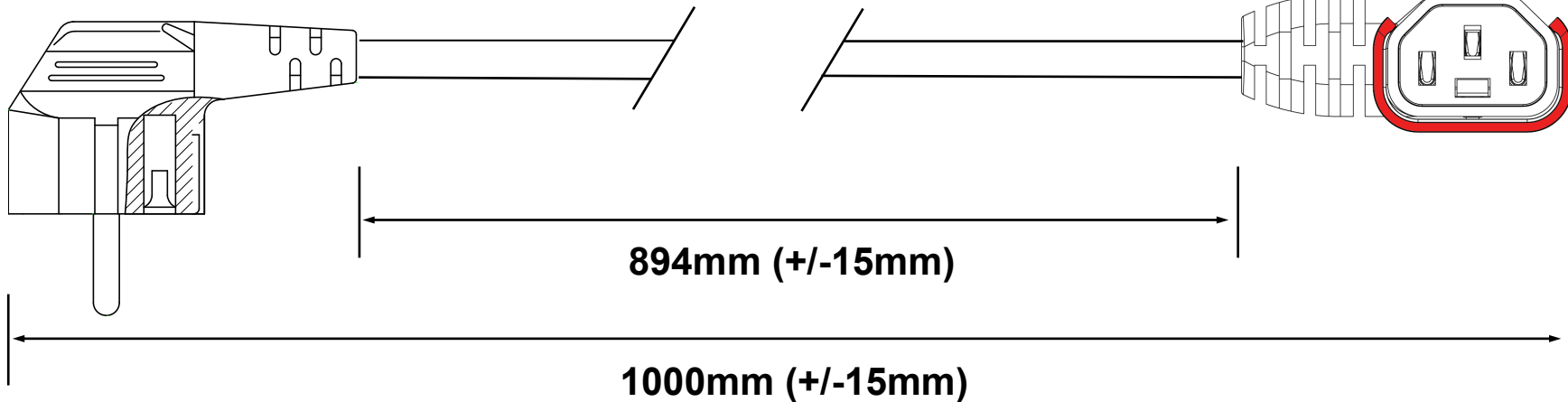

EXTRA REQUIREMENTS:
 PACKAGING OUTERTBC
 PIN PROTECTING COVERNO
 WIRING INSTRUCTIONSNO
 PRE-SHIPMENT INSPECTION REQUIRED....NO
COMMENTS:

CHANGE MANAGEMENT:

HANKING

**Fig.8
(200mm)**

TERMINATIONS / FURTHER COMMENTS: