

1	2
CUSTOMER NAME	
CUSTOMER Part No.	

7	8	9	10
DATE	REV	DESCRIPTION	BY
2020.11.17	A/0	NEW	XYH

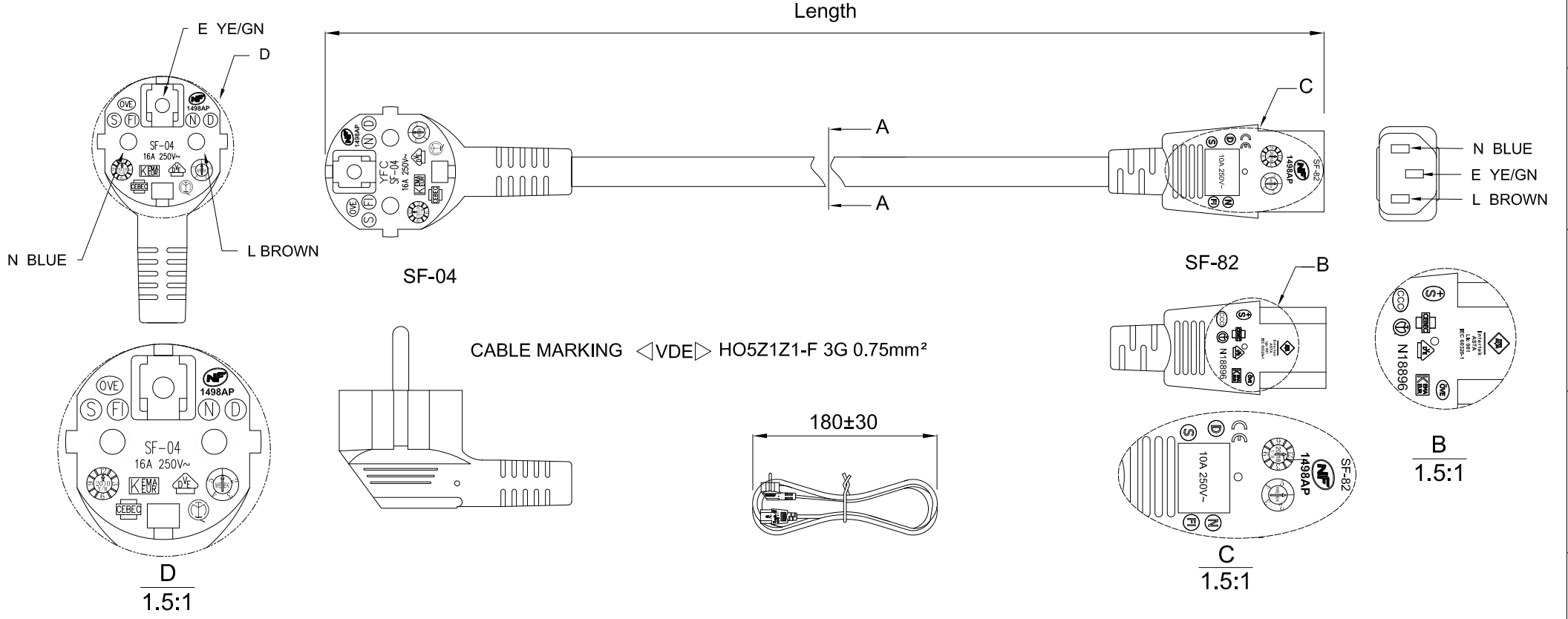

CABLE MARKING ◁VDE▷ HO5Z1Z1-F 3G 0.75mm²

Customer Item No	Colour	Length
AK5209	Black	1000±20
AK5210	Black	1500±20
AK5211	Black	2000±20

PINOUT			
SF-04		SF-82	WIRE
E		E	YE/GN
L		L	BROWN
N		N	BLUE

REMARKS:

- 1.POLARIZATION AND CONTINUITY TEST
- 2.DVW TEST:2000VAC,1S
- 3.PLUG(SF-04) RATED POWER:250V 16A
- 4.CONNECTOR (SF-82) RATED POWER:250V 10A
- 5.WIRE: H05Z1Z1-F 3G 0.75mm²x 3C RATED VOLTAGE: 300V/500V LSZH

WIRE MARKING: (Hollow)		◁VDE▷ HO5Z1Z1-F 3G 0.75mm ²						
Key Size	△	3RD	⊕					
Length (mm)	Tolerance							
	Critical	Normal	General					
0-15	±0.05	±0.10	±1.0	Part No.				
15-60	±0.10	±0.20		Description	H05Z1Z1-F 3G 0.75mm ² x3C BLACK SF-04 TO SF-82 CABLE ASSY			
60-150	±0.15	±0.35	±1.5	UNIT	mm	APPROVAL	CHECKER	DRAWER
150-350	±0.20	±0.50		PAGE	1/1	CQ	YB	XYH
350-1000	±0.40	±0.65	±2.0	Draw.No.				

1	2
CUSTOMER NAME	
CUSTOMER Part No.	

7	8	9	10
DATE	REV	DESCRIPTION	BY
2020.11.17	A/0	NEW	XYH

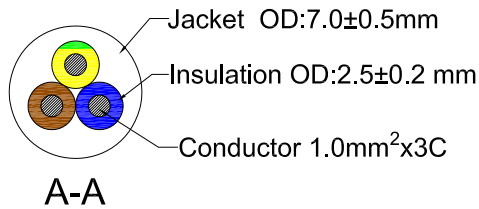
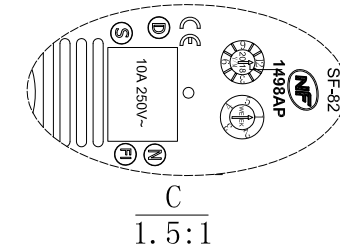
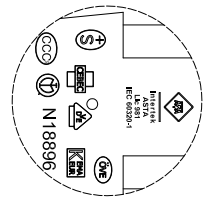
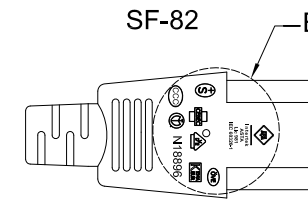
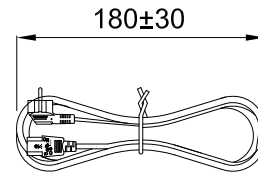
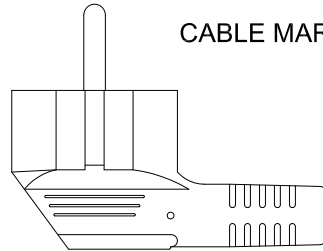
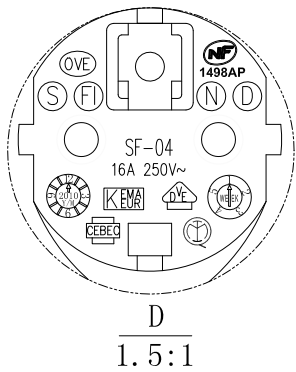
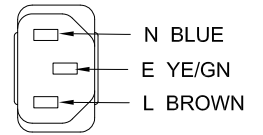
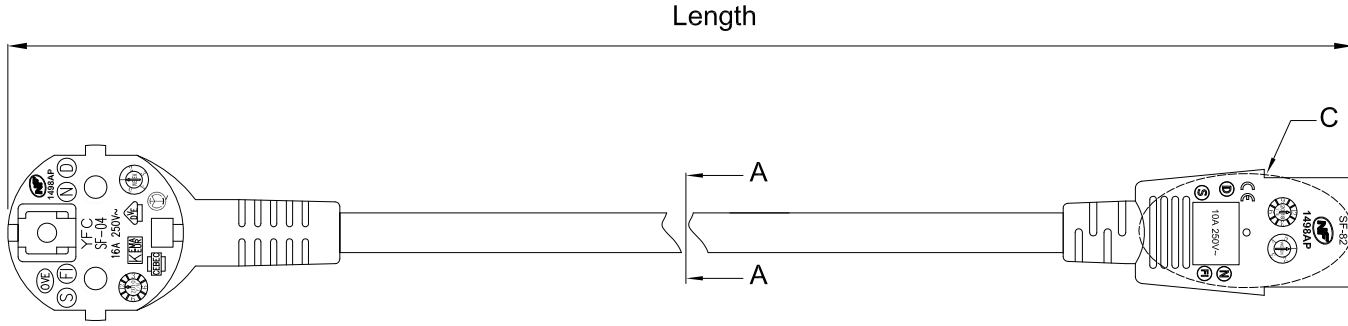
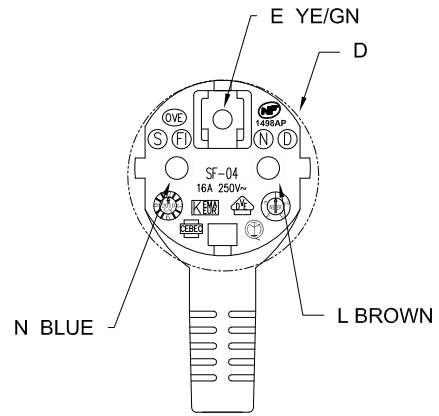

Customer Item No	Colour	Length
AK5212	Black	2500±30
AK5213	Black	5000±40

PINOUT			
SF-04		SF-82	WIRE
E		E	YE/GN
L		L	BROWN
N		N	BLUE

REMARKS:

- 1.POLARIZATION AND CONTINUITY TEST
- 2.DVW TEST:2000VAC,1S
- 3.PLUG(SF-04) RATED POWER:250V 16A
- 4.CONNCTOR (SF-82) RATED POWER:250V 10A
- 5.WIRE: H05Z1Z1-F 3G 1.0mm²X 3C RATED VOLTAGE: 300V/500V LSZH

WIRE MARKING: (Hollow)		<VDE> H05Z1Z1-F 3G 1.0mm ²		
Key Size	△	3RD		
Length (mm)	Tolerance			Part No.
	Critical	Normal	General	
0-15	±0.05	±0.10	±1.0	H05Z1Z1-F 3G 1.0mm ² x3C BLACK SF-06S TO SF-83 CABLE ASSY
15-60	±0.10	±0.20		
60-150	±0.15	±0.35	±1.5	UNIT
150-350	±0.20	±0.50		mm
350-1000	±0.40	±0.65	±2.0	PAGE
				1/1
Draw.No.				XYH