



Maverick 63104

4-Port USB 3-2-1 and DisplayPort 4Kp60 4:4:4
CAT 6a/7 100m Extender System

User Guide



Thank you for purchasing the Maverick 63104.

Please read this guide thoroughly.

FCC Radio Frequency Interference Statement Warning

This device complies with Part 15 of the FCC rules. Operation is subject to the following two conditions: (1) this device may not cause harmful interference, and (2) this device must accept any interference received including interference that may cause undesired operation.

CE Statement

We, ACT, declare under our sole responsibility that the Maverick 63104, to which this declaration relates, is in conformity with European Standards EN 55024, EN 55032, EN 61000, and RoHS Directive 2011/65/EU + 2015/863/EU.

IC Statement

This Class B digital apparatus complies with Canadian ICES-003 Issue 6.

WEEE Statement

The European Union has established regulations for the collection and recycling of all waste electrical and electronic equipment (WEEE). Implementation of WEEE regulations may vary slightly by individual EU member states. Please check with your local and state government guidelines for safe disposal and recycling or contact your national WEEE recycling agency for more information.

Product Operation and Storage

Please read and follow all instructions provided with this product and operate for intended use only. Do not attempt to open the product casing as this may cause damage and will void warranty. Use only the power supply provided with this product (if applicable). When not in use, product should be stored in a dry location between -20°C and 70°C.

©2019 ACT

All rights reserved.

Contents

Introduction	3
Product Contents	3
DisplayPort 1.2a Interface	4
The Local Extender	5
The Remote Extender	6
Installation Guide	7
Maverick 63104 Category Cabling Guidelines	7
Requirements for Installing the Maverick 63104 System	7
Preparing Your Site	8
Installing the Local Extender	9
Connecting the Local Extender to the Remote Extender	9
Installing the Remote Extender	9
Checking the Installation	9
Connecting a USB Device	10
Compatibility	10
Optional Ethernet Pass-Through Connection	10
Optional RS232 Pass-Through Connection	10
Optional USB Extender Mounting Options	11
Troubleshooting	13
Specifications	17
Contacting Technical Support	18

Introduction

This guide provides product information for the Maverick 63104, installation instructions and troubleshooting guidelines. The instructions in this guide assume a general knowledge of computer installation procedures, familiarity with cabling requirements and some understanding of USB devices.

 NOTE: Notes provide additional information that could be useful.

 CAUTION: Cautions provide important information about an operational requirement.

Product Contents

Your Maverick 63104 extender system contains:

- Local Extender
- Remote Extender
- USB 3.1 Gen 1 Cable
- Local Extender 24V DC 1A International Power Adapter
- Remote Extender 24V DC 2.71A International Power Adapter
- 2x Country Specific Power Cables
- 2x DisplayPort Cables
- 2x RS232 Mating Connectors
- Quick Start Guide

Features

The Maverick 63104 incorporates ExtremeUSB-C™ technology, enabling users to extend DisplayPort and USB 3.1 beyond the standard cable limit for peripherals, sinks, sources, and devices. This extender system is composed of two individual units, the Local Extender and the Remote Extender, and has the following key features:

- Support for DisplayPort 1.2a, up to 3840 x 2160 @60Hz 4:4:4 color and 10bpc
- Up to 100m of extension when directly connected over CAT 6a/7 cable
- Support for new USB 3.1 Gen 1/2 host controllers and devices (up to 5Gbps)
- Backwards compatible to USB 2.0 and 1.1 devices

The Maverick 63104 includes the ExtremeUSB-C™ suite of features:



- Transparent USB extension supporting USB 3, 2 and 1
- True plug and play; no software drivers required
- Works with all major operating systems: Windows®, macOS™, Linux® and Chrome OS™

 For best performance install the Maverick 63104 using Shielded or Foiled CAT 6a/7 cable.

DisplayPort 1.2a Interface

Resolutions

The maximum supported resolution through Maverick is 3840x2160 utilizing DP1.2a connectivity. The table below outlines the resolutions verified by ACT. For support of resolutions outside of this table, please contact Technical Support.

640x480	800x600	1024x768
1280x720	1280x768	1280x1024
1280x800	1360x760	1360x768
1440x900	1600x900	1680x1050
1920x1080	1920x1200	2560x1080
2560x1440	2560x1600	3440x1440
3840x2160		

Frame/Refresh Rate

Maverick is intended to provide support for resolutions listed in table 1 at 60Hz. Please contact ACT technical support for information about support for other refresh rates.

DisplayPort Audio

Up to 2 Channel 16/24 Bit Linear PCM, 32-192KHz Sample Rate audio is supported on the DisplayPort interface.

DisplayPort Multi-Stream Transport and DisplayPort Dual Mode

DisplayPort Multi-Stream Transport and DisplayPort Dual Mode are not supported.

Color Space Support

RGB Wide Gamut Floating Point, Y-Only, RAW, xvYCC-422, and YC_bC_r 4:2:2 are not supported.

EDID Handling

For the Maverick 63104, the EDID of the remote DisplayPort sink is copied to the Local Extender and remains until a new sink is detected in the system, **or** the Local Extender is power cycled.

The Local Extender

The Local Extender connects to the computer using the included USB 3.1 Gen 1 and DisplayPort cables. Power for this unit is provided by the included 24V 1A adapter.

Front View



Rear View

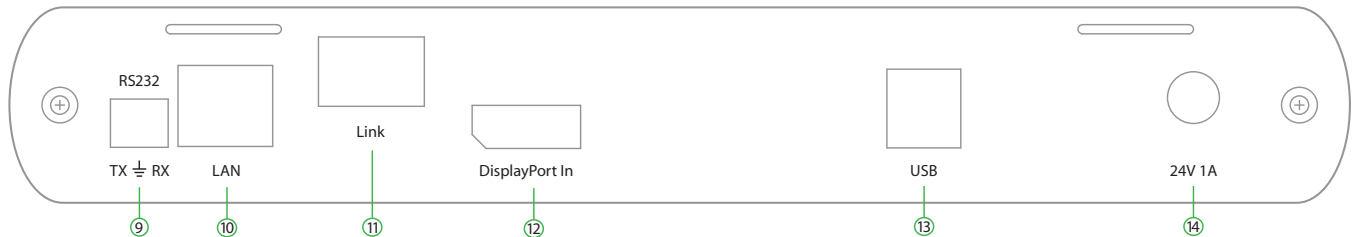

ITEM	TYPE	DESCRIPTION
1	Power LED	LED is SOLID ON when DC is supplied to the extender unit. LED is OFF when no power is supplied by the AC Adapter.
2	Mode	Reserved for manufacturer use.
3	Config	Reserved for manufacturer use.
4	Status LED	LED is SOLID ON when system is functioning normally. LED BLINKS when system is booting or to indicate a temperature warning in unison with the LINK, VIDEO, USB 2, and USB 3 LEDs.
5	Link LED	LED is SOLID ON when Local Extender is linked to an opposite Remote Extender. LED is OFF when there is no connection between the Local and Remote Extenders.
6	Video LED	LED is SOLID ON when an active DisplayPort connection is established through the extender system. LED is off when no DisplayPort connection is established.
7	USB 2 LED	LED is SOLID ON when an active USB 2 connection is established through the extender system. LED BLINKS when the USB 2 connection is suspended/asleep. LED is OFF when no USB 2 connection is detected.
8	USB 3 LED	LED is SOLID ON when an active USB 3 connection is established through the extender system. LED BLINKS when the USB 3 connection is suspended/asleep. LED is OFF when no USB 3 connection is detected.
9	RS232 Port	RS232 pass-through channel supporting up to 115200 baud. Connect to RS232 device.
10	LAN Port (RJ45)	100/1000 Mbps Ethernet pass-through channel connects to a network or Ethernet device.
11	Link Port (RJ45)	Accepts RJ45 connector for CAT 6a/7 cabling to connect the Local Extender to the Remote Extender.
12	DisplayPort In	DisplayPort 1.2a In/Sink Port. Connect to DisplayPort source.
13	USB Host Port	USB 3 Type B receptacle used to connect Local Extender to USB 3 Host computer.
14	DC Power Port	Locking connector for the included power adapter – accepts 24VDC 1A.

The Remote Extender

The Remote Extender provides a DisplayPort outlet and USB 3.1 Type A ports for standard USB devices and allows you to connect up to four USB devices directly. Additional devices may be connected by attaching up to three USB hubs to the Remote Extender. The Remote Extender is powered by an external AC 24V 2.71A adapter, supplying up to 1.2 Amp per USB port.

Front View

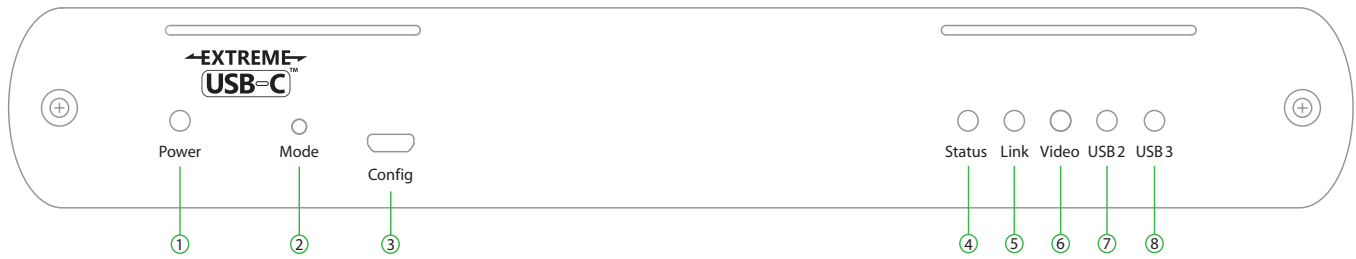

Rear View

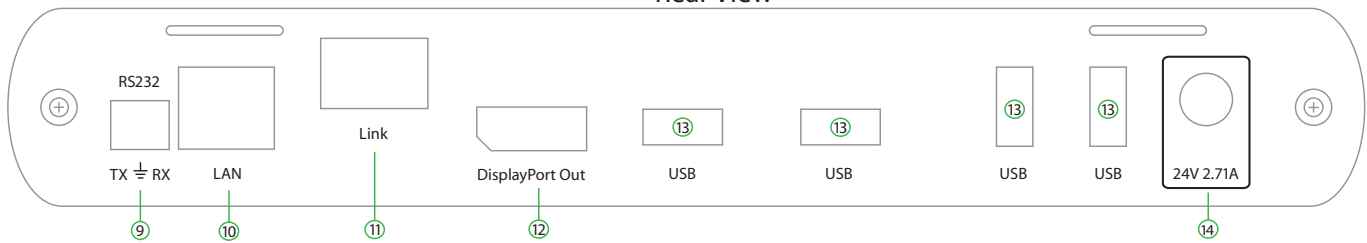

ITEM	TYPE	DESCRIPTION
1	Power LED	LED is SOLID ON when DC is supplied to the extender unit. LED is OFF when no power is supplied by the AC Adapter.
2	Mode	Reserved for manufacturer use.
3	Config	Reserved for manufacturer use.
4	Status LED	LED is SOLID ON when system is functioning normally. LED BLINKS when system is booting or to indicate a temperature warning in unison with the LINK, VIDEO, USB 2, and USB 3 LEDs.
5	Link LED	LED is SOLID ON when Remote Extender is linked to an opposite Local Extender. LED is OFF when there is no connection between the Local and Remote Extenders.
6	Video LED	LED is SOLID ON when an active DisplayPort connection is established through the extender system. LED is off when no DisplayPort connection is established.
7	USB 2 LED	LED is SOLID ON when an active USB 2 connection is established through the extender system. LED BLINKS when the USB 2 connection is suspended/asleep. LED is OFF when no USB 2 connection is detected.
8	USB 3 LED	LED is SOLID ON when an active USB 3 connection is established through the extender system. LED BLINKS when the USB 3 connection is suspended/asleep. LED is OFF when no USB 3 connection is detected.
9	RS232 Port	RS232 pass-through channel supporting up to 115200 baud. Connect to RS232 device.
10	LAN Port (RJ45)	100/1000 Mbps Ethernet pass-through channel connects to a network or Ethernet device.
11	Link Port (RJ45)	Accepts RJ45 connector for CAT 6a/7 cabling to connect the Remote Extender to the Local Extender.
12	DisplayPort Out	DisplayPort 1.2a Out/Source Port. Connect to DisplayPort sink.
13	Device Ports	Type A ports accepts all USB devices.
14	DC Power Port	Locking connector for the included power adapter – accepts 24VDC 2.71A.

Installation Guide

Maverick 63104 Category Cabling Guidelines

The Maverick 63104 requires a minimum grade of Category 6a cabling to be used in order to reach 100m (328 ft) of extension distance.

 The total distance of 100m also includes the length of the patch cable should one be required. Up to 10m of patch cable can be used, although the remaining 90m distance must consist of solid core premise cabling.

Furthermore, depending upon specific application requirements, it is recommended that installers keep in mind how they intend to pull/route the link cable and whether to use Shielded or Foiled cable where appropriate.

When installing this product, it is appropriate to use Unshielded (UTP) cabling if the cable run installation meets the following requirements:

- The cable is **not** bundled with other cables
- The cable is **run loosely** with other Category cables
- The cable is **not** placed close to sources of interference such as power lines and radios
- The cable is **not** looped or coiled

When installing this product, Foiled (FTP) or Shielded (STP) cabling must be used if the cable run installation requires the following cable run installation:

- The cable is bundled with other cables
- The cable is run tight against other Category cables
- The cable is placed near sources of interference like power lines and radios
- The cable is looped or coiled

 For best performance install the Maverick 63104 using Shielded or Foiled CAT 6a/7 cable.

Requirements for Installing the Maverick 63104 System

To complete the installation, you will also require the following items that are not included with this system:

- USB compatible computer (host computer) with a USB compliant operating system
- USB compatible device(s)
- CAT 6a/7 Unshielded Twisted Pair (UTP) cable with two RJ45 connectors (if using surface cabling), or CAT 6a/7 cabling with two information outlets and two CAT 6a/7 patch cords with RJ45 connectors (if using premise cabling), ensuring the total cable length does not exceed 100m.

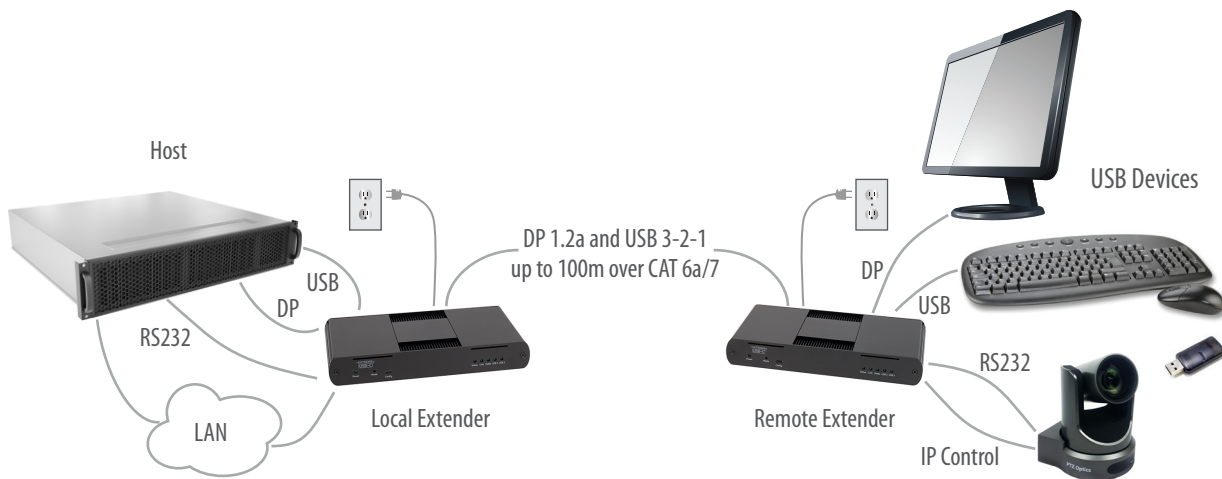

Preparing Your Site

Before installing the Maverick 63104 extender, you will need to prepare your site:

1. Place the computer where desired and set it up.
2. Ensure to locate your USB device(s) within the cable-length of the computer. If not, adjust the location of your device(s) and/or computer accordingly.

note If you are using surface cabling, the Maverick 63104 supports a maximum distance of 100m. Install the CAT 6a/7 cabling as desired and terminate it with the appropriate RJ45 ends. If using premise cabling, (in-building network infrastructure), ensure your cabling is installed between the two locations and does not exceed 100m and that it meets CAT 6a/7 specification.

! Cable installation is important, particularly if high throughput applications are used. When installing, ensure the cable is installed away from, or isolated from potential sources of interference such as electrical wiring, fluorescent lighting, etc.

note When terminating cables, ensure the matching RJ45 connector is used for the cable type. For example, if CAT 6a cable is used, then CAT 6a compatible RJ45 connectors must be used. Otherwise, the benefits of using higher grade cabling may not be realized.

note Must use included DisplayPort cables when connecting to USB Host and DisplayPort sources and sinks.

Installing the Local Extender

1. Place the Local Extender near the computer.
2. Assemble the power adapter and country specific power cord together and connect them into a suitable AC outlet.
3. Connect the supplied USB 3.1 Gen cable between the Local Extender host port and a USB 3 port on the host computer.
4. Connect the supplied DisplayPort cable between the Local Extender and the DisplayPort source.

Connecting the Local Extender to the Remote Extender

With Surface Cabling:

1. Plug one end of the CAT 6a/7 cable (not included) into the Link port on the Local Extender.
2. Plug the other end of the CAT 6a/7 cable into the Link port on the Remote Extender.

With Premise Cabling:

1. Plug one end of a CAT 6a/7 patch cord (not included) into the Link port on the Local Extender.
2. Plug the other end of the patch cord into the CAT 6a/7 information outlet near the host computer.
3. Plug one end of the second CAT 6a/7 patch cord (not included) into the Link port on the Remote Extender.
4. Plug the other end of the patch cord into the CAT 6a/7 information outlet near the USB device.



Do not exceed more than 10m total of patch cable when using premise cabling.

Installing the Remote Extender

1. Place the Remote Extender near the USB device(s).
2. Assemble the power adapter and country specific power cord together and connect them into a suitable AC outlet.
3. Connect the power adapter to the Remote Extender.
4. Connect the supplied DisplayPort cable between the Local Extender and the DisplayPort sink.

Checking the Installation

1. On the Local and Remote Extenders, check that the Power, Status, Link, USB 2 and USB 3 LEDs are on. If the Link LEDs are permanently off, then the cabling between the Local and Remote Extender may not be installed properly or is defective.
2. For Windows users (7, 8.1, 10), open Device Manager to confirm that the extender system has been installed correctly. Expand the entry for Universal Serial Bus controllers by clicking the "+" sign. If the extender system has been installed correctly, you should find two separate instances of "Generic SuperSpeed USB Hub" listed.



To open Device Manager in Windows 7:

Open the Start Menu, right click on "Computer" then select: Manage >> Device Manager



To open Device Manager in Windows 8.1 or 10:

Right click the Start Menu and then select: Device Manager

- For macOS users, open the System Profiler to confirm that the extender system has installed correctly. In the left-hand column under Hardware, select “USB” and inspect the right-hand panel. If the extender has been installed correctly, you should find it listed as two separate instances of “Hub” under the USB SuperSpeed Bus.



To open System Profiler in macOS:

Open the Finder, select Applications, then open the Utilities folder and double click on the System Profiler icon.

- If the extender system is not detected correctly or fails to detect, please consult the Troubleshooting section in this guide.

Connecting a USB Device

- Install any software required to operate the USB device. Refer to the documentation for the USB device, as required.
- Connect the USB device to the device port on the Remote Extender.
- Check that the device is detected and installed properly in the operating system.

Compatibility

The Maverick 63104 complies with DisplayPort 1.2a, USB 2.0 and USB 3.1 Gen 1 specifications. However, there is no guarantee that all DisplayPort and USB devices or hosts will be compatible as there are a number of different characteristics that may impact the operation of DisplayPort sources/sinks or USB devices over extended distances.

Optional Ethernet Pass-Through Connection

The Maverick 63104 offers a 100/1000 Mbps Ethernet pass-through connection that can be used for a variety of purposes including:

- Connecting network devices
- Providing remote network access to the same location as the Remote Extender
- Leveraging existing cabling to provide DisplayPort 4Kp60 and USB 3-2-1 connectivity without losing network connectivity

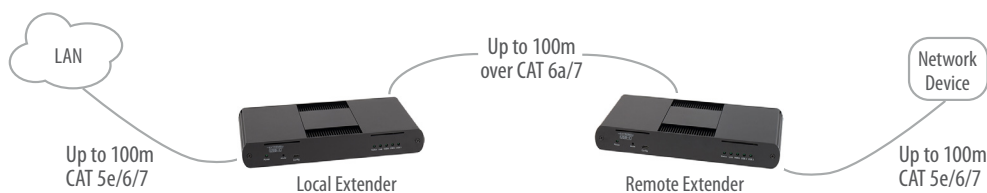

Connect any network device or access port into the RJ45 socket label “LAN” using up to 100 meters of standard CAT 5e, 6 or 7 cabling.

Optional RS232 Pass-Through Connection

The Maverick 63104 offers an RS232 pass-through connection that can be used for a variety of purposes including:

- Connecting RS232 devices
- Connecting RS232 based control interfaces

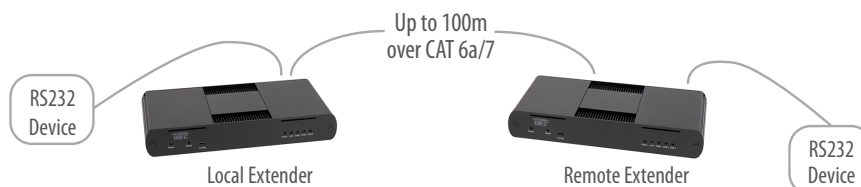

Optional USB Extender Mounting Options

The bottom of the enclosure features four convenient pre-drilled holes for optional mounting. Based on your requirements, choose from two available mounting options:

- 1. USB Extender Mounting Kit** (Purchased separately)
AC7751 Raven/Maverick Black Mounting Kit)
- 2. USB Extender Direct Surface Mounting** (Using your own hardware, stencil provided on page 12)

OPTION 1: USB Extender Mounting Kit

Contents:

- 2 mounting brackets
- 4 (M3) locking washers
- 4 (M3 x 10mm) Phillips screws
- Mounting bracket installation guide (*see diagram below*)

1 kit required to mount per Local Extender or Remote Extender

Using a Phillips screwdriver, in the order as illustrated below, fasten and secure the provided screws, locking washers and brackets into place.

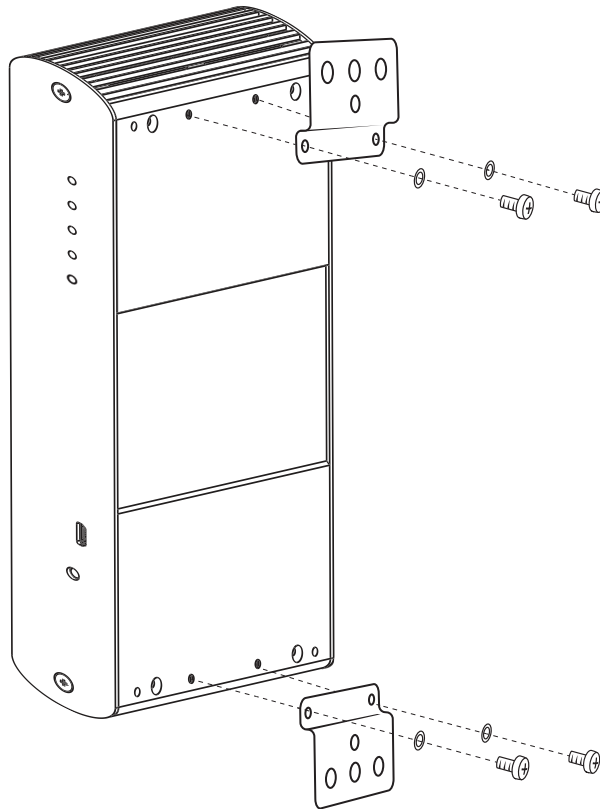

Once the bracket mounting is secured onto the extender, it is ready for mounting onto a surface. Please note you will need to provide your own screws to secure the extender using the available slots on each bracket.

OPTION 2: USB Extender Direct Surface Mounting (using your own hardware)

The bottom of the enclosure features four pre-drilled holes for optional surface mounting.

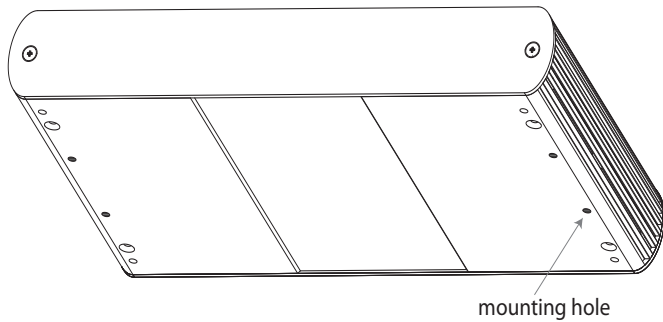

Distance between the enclosure mounting holes:
42.0mm x 205.5mm

1. Mark the center point of each of the four holes on your mounting surface either by directly measuring.
2. Hardware recommendation: M3 locking washers and M3 screws (4 of each per extender) noting screw length will depend upon thickness of mounting surface.
3. Drill through each of the four-hole markings on the mounting surface using a 3.97mm (5/32") drill bit.
4. Align the bottom enclosure holes to the newly drilled out holes on the mounting surface.
5. Place a locking washer on each of the four screws and using a screwdriver, fasten the extender into place.



Do not exceed a screw depth of 10mm (0.4") into the unit or damage may occur.

Direct Surface Mounting Measurement Stencil

The stencil illustration pictured below is only 50% of the original size.



Troubleshooting

The following table provides troubleshooting tips. The topics are arranged in the order in which they should be executed in most situations. If you are unable to resolve the problem after following these instructions, please contact Technical Support for further assistance.

PROBLEM	CAUSE	SOLUTION
ALL LEDs are OFF on the Local and/or Remote Extender.	1. The Local Extender and/or Remote Extender is not receiving power from the AC power adapter.	1. Ensure that the AC power adapter is properly connected to the Local Extender and/or Remote Extender. 2. Check that the AC adapter is connected to a live source of AC power. Check that the Local and/or Remote Extender's Power LED is illuminated.
POWER LED is ON, STATUS LED is OFF.	1. The unit has malfunctioned and requires re-programming.	1. Contact Technical Support for assistance.
Link LEDs on the Local and Remote Extenders are OFF.	1. There is no connection between the Local and Remote Extenders.	1. Ensure that no more than 100m of CAT 6a/7 cabling is connected between the Local and Remote Extenders. 2. Connect a short patch cable between the Local and Remote Extenders. Recheck the link status. If the LINK LED is now SOLID ON, the previous cable is defective or not capable of supporting the link.
LINK LEDs on the Local and Remote Extenders are SOLID ON, but the USB 2 and USB 3 LEDs are OFF.	1. The host computer is not powered on. 2. The Local Extender is not connected to a computer. 3. The host computer does not support USB Hubs. 4. The unit is malfunctioning.	1. Disconnect all USB devices from the Remote Extender. 2. Disconnect Local Extender from the host computer. 3. Disconnect AC adapters from Local and Remote Extenders. 4. Reconnect the Local Extender to the host computer. 5. Reconnect the AC adapters to the Local and Remote Extenders. 6. Check that the Local and Remote Extenders have enumerated as USB hubs in Windows Device Manager, macOS System Profiler or using "lsusb" command in a Linux Terminal. 7. If the problem is not resolved, contact Technical Support.
The USB 2 LED is SOLID ON, but the USB 3 LED is OFF.	1. The Local Extender is not connected to a USB 3 port. 2. The Local Extender is connected to the host using a USB 2 cable. 3. The USB 3 cable connecting the Local Extender to the host computer is defective. 4. The host computer's USB 3 controller has malfunctioned.	1. Ensure that the Local Extender is connected to a USB 3 port on the host computer. 2. Ensure that the included USB 3.1 Gen 1 cable is being used between the host computer and Local Extender. 3. Cold boot the host computer. 4. Replace the USB 3.1 Gen 1 cable with a different cable. 5. If the problem is not resolved, contact Technical Support.

PROBLEM	CAUSE	SOLUTION
The USB 3 LED is SOLID ON, but the USB 2 LED is OFF.	<ol style="list-style-type: none"> 1. The USB cable connecting the Local Extender to the host computer is defective. 2. The host computer's USB 2.0 controller has malfunctioned. 3. The host computer does not support USB 2. 	<ol style="list-style-type: none"> 1. Ensure that the included USB 3.1 Gen 1 cable is being used between the host computer and Local Extender. 2. Cold boot the host computer. 3. Replace the USB 3.1 Gen 1 cable with a different cable. 4. If the problem is not resolved, contact Technical Support.
Both the Local and Remote Extenders are working, but the USB 2 or USB 3 LEDs on the Local and Remote Extenders are blinking.	<ol style="list-style-type: none"> 1. The Local and/or Remote Extender is in suspend mode. For a variety of reasons, the host computer may place the Local/Remote Extender into suspend mode. Typically, it is because there are no USB devices attached, the USB device is asleep, or the host computer is in a sleep state or hibernating. 	<ol style="list-style-type: none"> 1. Recover/resume the operating system from sleep or hibernate modes (refer to your operating system's documentation). 2. Connect a USB device to the Remote Extender. 3. Use the connected device. 4. If the problem persists, contact Technical Support.
ALL LEDs on both the Local and Remote Extenders are SOLID ON, but the USB device is not operating correctly, or is detected as an "Unknown Device" in the operating system.	<ol style="list-style-type: none"> 1. The USB device is malfunctioning. 2. The computer does not recognize the USB device. 3. The application software for the USB device is not operating. 4. The USB extender is malfunctioning. 	<ol style="list-style-type: none"> 1. Disconnect the extender from the computer. 2. Connect the USB device directly to the host computer. 3. If the device does not operate as expected, consult the user documentation for the device. 4. Update the host computer BIOS, chipset or USB controller drivers from the manufacturer's website. 5. If the device operates as expected when directly connected to the computer, connect another device to the extender and reconnect it to the host computer. 6. If the second device does not operate, the extender may be malfunctioning. Contact Technical Support for assistance. 7. If the second device operates as expected, then the first device may not be compatible with this extender. Contact Technical Support.

PROBLEM	CAUSE	SOLUTION
<p>A USB 3 device is not enumerating as USB 3, or the operating system is notifying the user that the device can "Perform Faster if connected to a USB 3 port".</p>	<ol style="list-style-type: none"> 1. The USB device is malfunctioning. 2. The computer does not recognize the USB device. 3. The application software for the USB device is not operating. 4. The USB 3 port on the computer is malfunctioning. 5. The USB extender is malfunctioning. 	<ol style="list-style-type: none"> 1. Disconnect the extender from the computer. 2. Connect the USB 3 device directly to the host computer. 3. If the device does not operate as expected as a USB 3 device, consult the user documentation for that device or try a different USB port on the host computer. 4. Update the host computer BIOS, chipset or USB controller drivers from the manufacturer's website. 5. If the device operates as USB 3 device when directly connected to the computer, connect another USB 3 device to the extender and reconnect it to the host computer. 6. If the second device does not operate as a USB 3 device, the extender may be malfunctioning. Contact Technical Support for assistance. 7. If the second device operates as a USB 3 device as expected, the first device may not be compatible with this extender. Contact Technical Support.
<p>The Link LEDs on the Local Extender and Remote Extenders are solid ON, but the Video LED is OFF.</p>	<ol style="list-style-type: none"> 1. The source device is not powered on or asleep. 2. The Local Extender is not connected to a DisplayPort source. 3. The Remote Extender is not connected to a DisplayPort sink, or the sink is turned off. 4. The source and sink have negotiated an unsupported resolution or refresh rate. 5. The extender system is malfunctioning. 	<ol style="list-style-type: none"> 1. Disconnect the DisplayPort connections from the sink and source. 2. Disconnect the AC adapters from the Local and Remote extenders. 3. Cold boot the host computer/DisplayPort source. 4. Reconnect the DisplayPort connection from the Local Extender to the DisplayPort source. 5. Reconnect the DisplayPort connection from the Remote Extender to the DisplayPort sink. Ensure the sink is on. 6. Reconnect the AC adapters to the Local and Remote Extenders. 7. If the problem is not solved, contact Technical Support.

PROBLEM	CAUSE	SOLUTION
The Link and Video LEDs are solid ON, but there is no video on the DisplayPort sink.	<ol style="list-style-type: none"> 1. The DisplayPort sink device is malfunctioning. 2. The DisplayPort source is malfunctioning. 3. The Remote Extender is not connected to a DisplayPort sink. 	<ol style="list-style-type: none"> 1. Disconnect the DisplayPort connections from the sink and source. 2. Disconnect the AC adapters from the Local and Remote Extenders. 3. Restart the host computer/ DisplayPort source. 4. Connect the sink directly to the source using supplied DisplayPort cables and ensure it operates properly. 5. If the sink does operate directly connected to the source, try connecting another sink device through the extender system. 6. Reconnect the DisplayPort connection from the Local Extender to the DisplayPort source. 7. Reconnect the DisplayPort connection from the Remote connection to the DisplayPort sink. 8. Reconnect the AC adapters to the Local and Remote Extenders. 9. If the problem is not solved, contact Technical Support.
All LEDs are flashing and the system is operational.	<ol style="list-style-type: none"> 1. Unit is or was operating at an unsafe temperature. 	<ol style="list-style-type: none"> 1. Check ambient temperature. Ensure temperature does not exceed 50°C (122°F). 2. Power cycle the unit to remove LED status.
All LEDs are flashing and the system is NOT operational.	<ol style="list-style-type: none"> 1. Unit has exceeded safe operating temperature. 	<ol style="list-style-type: none"> 1. Remove external sources of heat or change location of the unit. 2. Power cycle the unit to return to operation.
LEDs are scrolling LEFT to RIGHT, starting with STATUS.	<ol style="list-style-type: none"> 1. Unit is programming. 	<ol style="list-style-type: none"> 1. Wait for the unit to finish programming.

Specifications

RANGE	
Point-to-Point	Up to 100m (328 ft) over CAT6a/7 Cable
USB DEVICE SUPPORT	
Maximum Throughput	5 Gbps
Traffic Types	All Traffic Types
Maximum Number of Devices and/or Hubs	Up to 30 devices
LOCAL EXTENDER	
USB Connector	1 x USB 3.1 Gen 1 Type B Receptacle
Link Connector	1 x RJ45 "LINK"
Network Pass Through	1 x RJ45 "LAN"
DisplayPort Connector	1x DisplayPort 1.2a Receptacle
RS232 Connector	1x 3pin Terminal Block
Dimensions	137.3mm x 232.1mm x 33.0mm (5.4" x 9.1" x 1.3")
Enclosure Material	Black Anodized Aluminum
Power Supply	100-240V AC Input, 24V 1A DC Output
REMOTE EXTENDER	
USB Connector	4 x USB 3.1 Gen 1 Type A Receptacles
Link Connector	1 x RJ45 "LINK"
Network Pass Through	1 x RJ45 "LAN"
DisplayPort Connector	1x DisplayPort 1.2a Receptacle
RS232 Connector	1x 3pin Terminal Block
Dimensions	137.3mm x 232.1mm x 33.0mm (5.4" x 9.1" x 1.3")
Enclosure Material	Black Anodized Aluminum
Available Current	Up to 1.2 Amp (6W) to each USB port
Power Supply	100-240V AC Input, 24V 2.71A DC Output
ENVIRONMENTAL	
Operating Temperature Range	0°C – 50°C (32°F – 122°F)
Storage Temperature Range	-20°C – 70°C (-4°F – 158°F)
Operating Humidity	20% to 80% relative humidity, non-condensing
Storage Humidity	10% to 90% relative humidity, non-condensing
COMPLIANCE	
EMC	FCC (Class B), CE (Class B)
Environmental	RoHS2 (CE)
SUPPORT	
Warranty	2-year

Contacting Technical Support

If you are experiencing problems not referenced in the Troubleshooting section, or require further assistance, contact Technical Support at the company where you purchased this product and include the following information:

- Host computer make and model
- Type of Operating System installed (e.g. Windows 10, macOS 10.12, etc.)
- Part number and serial number for both the Local and Remote Extender units
- Make and model of any USB device(s) attached to this extender system
- Description of the installation such as Host computer model and transmission media used
- Information about the USB and DisplayPort peripherals used
- Description of the problem

Technical Glossary

Category 6a/7 (CAT 6/7) Network Cabling

Category 6a/7 cable is commonly also referred to as CAT 6a or CAT 7. This cabling is available in either solid or stranded twisted pair copper wire variants and as UTP (Unshielded Twisted Pair), FTP (Foiled Twisted Pair) or STP (Shielded Twisted Pair). UTP cables are not surrounded by any shielding making them more susceptible to Electromagnetic Interference (EMI). FTP/STP cables include shielding the copper wires and provide better protection against EMI.

USB 3 and USB 2.0 Cables

USB cables have two distinct full-sized connectors. The Type A connector is used to connect the cable from a USB device to the Type A port on a computer or hub. The Type B connector is used to attach the USB cable to a USB device.

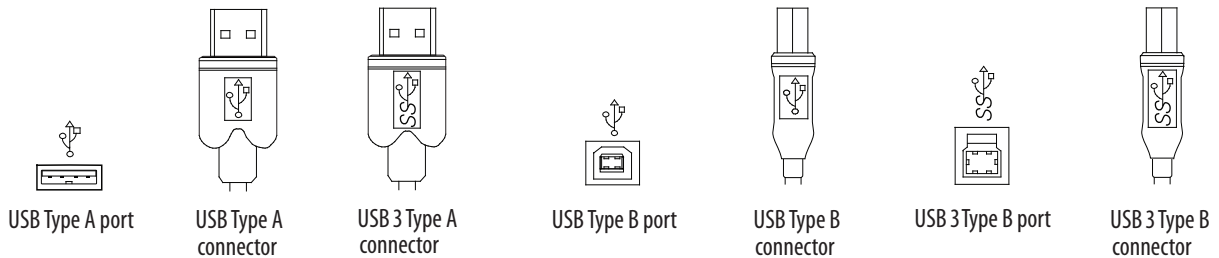

RJ45

The Registered Jack (RJ) physical interface is what connects the network cabling (CAT 6a/7) to the Local and Remote Extenders. You may use either the T568A scheme (Table 1) or the T568B scheme (Table 2) for cable termination as the Maverick 63104 requires all four pairs of the cable. RJ45 connectors are sometimes also referred to as 8P8C connectors. Note that any give cable must be terminated using the same T568 scheme on both ends to operate correctly.

RJ45 Pin Positioning

Table 1 - T568A Wiring

PIN	PAIR	WIRE	CABLE COLOR
1	3	1	WHITE/GREEN
2	3	2	GREEN
3	2	1	WHITE/ORANGE
4	1	2	BLUE
5	1	1	WHITE/BLUE
6	2	2	ORANGE
7	4	1	WHITE/BROWN
8	4	2	BROWN

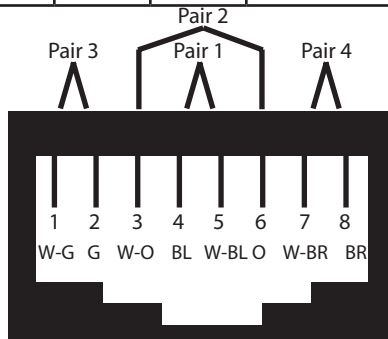

Table 2 - T568B Wiring

PIN	PAIR	WIRE	CABLE COLOR
1	2	1	WHITE/ORANGE
2	2	2	ORANGE
3	3	1	WHITE/GREEN
4	1	2	BLUE
5	1	1	WHITE/BLUE
6	3	2	GREEN
7	4	1	WHITE/BROWN
8	4	2	BROWN

